



RHOMTUFT®



BADTEPPICHE | FROTTIER | ACCESSOIRES

RHOMTUFT,
MADE IN GERMANY
SINCE 1959.



21 FARBEN / KOMBI-FARBSTREIFEN

für Badteppiche aus Baumwolle, Antrongarn und die dazu passenden Frottierartikel



Badteppiche aus 100% Baumwolle/cotton

sind in Standardgrößen, als Wunschmaßanfertigungen, in Wunschformen und nach Schablone/Skizze erhältlich.

Zentimetergenaue Anfertigungen sind nach Schablone/Skizze aufgrund von Maßtoleranzen (+/-3 %) nicht zu empfehlen.

Keine Rücknahme von Sonderanfertigungen.
Alle Größen sind ca. Angaben.

Lieferzeit

Standardgrößen: 2-3 Tage
Sonderanfertigungen: 6-8 Wochen

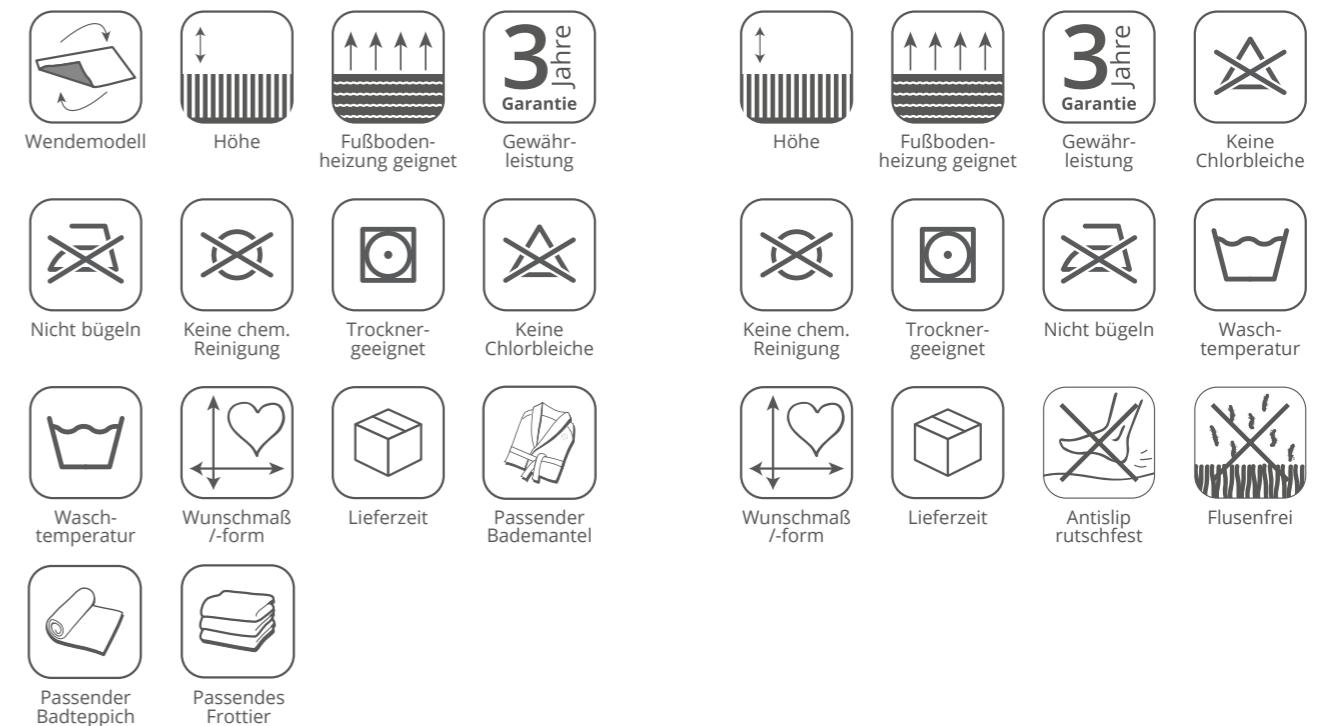

Badteppiche aus Antrongarn (Polyamid)

sind in Standardgrößen, als Wunschmaßanfertigungen, in Wunschformen und nach Schablone/Skizze erhältlich.

Einzelfertigung, keine Rücknahme, kein Umtausch.

Lieferzeit

Standardgrößen: 2-3 Tage
Sonderanfertigungen: 14 Tage



RHOMTUFT®

INHALT

ERLÄUTERUNGEN.....	4
VORWORT	7
UNSERE MANUFAKTUR.....	9
BAUMWOLLE GETUFTET	11
290 PUR.....	13
45 PRESTIGE.....	15
46 EXQUISIT.....	17
WUNSCHMASSPROGRAMM	19
02 LIN	21
BAUMWOLLE GEWEBT	23
56 SAILOR	25
51 PEARL	27
03 GALA.....	29
54 SEASIDE	31
58 PLAIN.....	33
09 COMTESSE.....	35
53 MAURO	37
FROTTIER.....	39
69 BARONESSE.....	41
69 BARONESSE BADEMANTEL	43
66 PRINCESS.....	45
250 SIR & LADY.....	47
68 FACE & BODY	49
68 FACE & BODY BADEMANTEL.....	51
67 LOFT	53
09 COMTESSE.....	55
STICK-SERVICE	57
71 BEACH.....	59
HOLZACCESSOIRES	61
190 SPA	61
186 ENJOY	62
POLYAMID-BADTEPPICHE.....	63
10 ASPECT.....	65
18 SQUARE	66
INLAY-SERVICE	67
360 EFFECT	69
362 BAHAMA.....	69
361 RAUTE.....	70
363 BOLREO	70
WUNSCHMASSPROGRAMM	71
POLYACRYL-BADTEPPICHE	73
24 AMBIENTE.....	75
36 MÅANDER.....	77
31 CUBUS.....	79
87 RHOM.....	81
300 CABLE.....	83
301 FRAME	85
302 PUZZLE	87
216 STAR	88
243 STEP 308 STONE.....	91
306 ANANAS 223 ANKER 135 LINEA.....	93
303 MÅANDER MONO 233 STARFISH	95
37 OLYMP 122 SWOOP.....	95
244 VIVO 304 MONSTERA 327 LUNA 237 MARITIM	97
WEITERE MOTIVE.....	99
20 COMPACT 22 COMFORT.....	103
WASCH- UND PFLEGEHINWEISE	107
FARBEN	
KOMBI-FARBSTREIFEN	3
POLYACRYL-COLORBOX	108



Herzlich Willkommen

in der RHOMTUFT-Manufaktur.

Seit fast 150 Jahren und inzwischen in der 5. Generation befasst sich meine Familie mit der Herstellung von Haustextilien. Mit meinem Urgroßvater Wilhelm Golze begann es 1873 in Landsberg an der Warthe. Es folgten mein Großvater Otto und mein Vater Dr. Egon Golze, die in Hameln an der Weser Läufer, Auto-, Fuß- und Badematten herstellten. Seit nunmehr 35 Jahren leite ich das Unternehmen RHOMTUFT als geschäftsführender Gesellschafter und die nächste Generation ist mit meiner ältesten Tochter Gloria bereits am Start und bringt neue Impulse und innovative Ideen in unser erfahrenes Team. So können wir hoffnungsvoll in die Zukunft schauen!

RHOMTUFT ist inzwischen das einzige Unternehmen, das Badteppiche in Deutschland herstellt und wir bleiben unserer Tradition „Made in Germany“ weiter treu. Die Fertigung hier in unserer Manufaktur in Emmerthal und der Einsatz neuester Technologien machen es möglich, dass Sie als unsere Kunden und Fachhändler vieles aus unserer Produktpalette nach Ihren ganz persönlichen Wünschen in Sondermaßen, -formen und -farben gestalten lassen können. Tradition und Innovation sind unsere Stärken.

Wir sind stolz darauf, Ihnen heute unseren neuen Katalog präsentieren zu können. Unser Design-Team hat mit viel Kreativität und Herzblut neue Kollektionen und Farben entwickelt, die ganz im Lifestyle-Trend liegen. Lassen Sie sich von unseren Badteppichen, unseren Frottierkollektionen, Bademänteln und Accessoires begeistern.

Mit besten Grüßen aus dem Weserbergland

Egon A. Golze



Mit Tuftmaschinen wie dieser entstehen in handwerklicher Präzision unsere getufteten Badteppiche aus rohweisser Baumwolle, z.B. PRESTIGE, PUR oder EXQUISIT.

Dabei verwenden wir hochwertiges Grundgewebe und ringgesponnene Garne für jedes Unikat. Anschließend gehen die Badteppiche in die Färbung.

An Tuftmaschinen, an denen wir Acrylgarne verarbeiten, beginnt das Tuften erst, wenn die Bestellung und damit der individuelle Wunsch des Kunden vorliegt. Garnkonen werden aufgesteckt, die Maschine wird eingerichtet und der Badteppich entsteht.

Unsere Mitarbeiter achten dabei auf handwerkliche Präzision und höchste Sorgfalt bei der Ausführung Ihres Wunsches. Das sieht und spürt man.

Auf YouTube sehen Sie, wie ein individueller Bad-Teppich entsteht. Einfach nebenstehende QR-Codes scannen und Video anschauen.



FEINE
MATERIALIEN.

HOCHWERTIGE
VERARBEITUNG.



BADTEPPICHE
AUS REINER
BAUMWOLLE.

NATÜRLICH,
EDEL, ZEITLOS.



PUR | PRESTIGE | EXQUISIT | LIN



320 stone



290 | PUR

	ca. cm	Art.-Nr.
	50 x 75	290 13 100
	60 x 60	290 13 160
	60 x 100	290 13 180
	70 x 130	290 13 230
	45 x 50	290 62 050
	max. 135 x 350 Ø 135	290 560

100% Baumwolle/cotton
Gewicht ca. 2.250 g/m²
Schlinge/Velours



78 aqua



405 peach

45 | PRESTIGE

	ca. cm	Art.-Nr.
	45 x 60	45 13 060
	50 x 75	45 13 100
	60 x 60	45 13 160
	60 x 100	45 13 180
	70 x 130	45 13 230
	80 x 160	45 13 280
	60 x 60	45 53 160
	45 x 50	45 62 050
	max. 135 x 350 Ø 135	45 560







90 jade



100% Baumwolle/cotton
Gewicht ca. 2.250 g/m²
Schlinge/Velours



46 | EXQUISIT

	ca. cm	Art.-Nr.
	50 x 75	46 12 100
	60 x 100	46 12 180
	70 x 130	46 12 230
	80 x 160	46 12 280
	ø 80	46 27 435
	ø 100	46 27 445
	60 x 60	46 52 160
	45 x 50	46 62 050
	max. 135 x 350 Ø 135	46 560



20 natur



100% Baumwolle/cotton
Gewicht ca. 2.250 g/m²
Schlinge/Velours



7 Basisfarben innerhalb
2-3 Werktage ab Lager
lieferbar. **Alle anderen
Farben** lieferbar inner-
halb 6-8 Wochen.
(Siehe vordere
Umschlagseite)

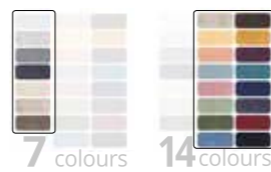

58 taupe

Badteppiche nach Ihren Wünschen: Wählen Sie Ihren Favoriten zum Wunschmaß-Preis

Wählen Sie aus den unten stehenden Wunschformen und 4 attraktiven Modellen Ihren Lieblings-Badteppich. 21 moderne Farben und Größen ab 50 x 50 bis max. 135 x 350 cm lassen dabei unendliche Möglichkeiten zu.

Wunschformen:

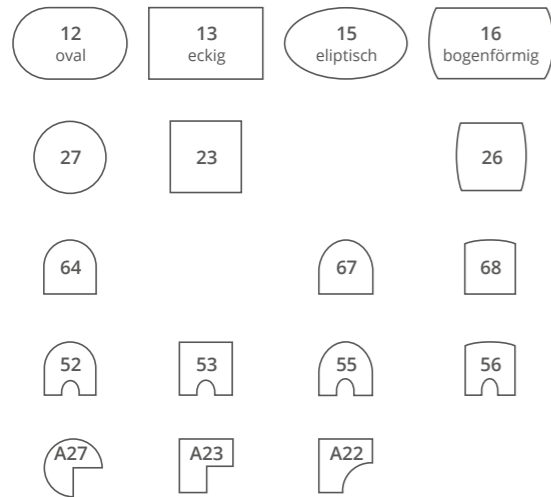

Wunschmodelle:

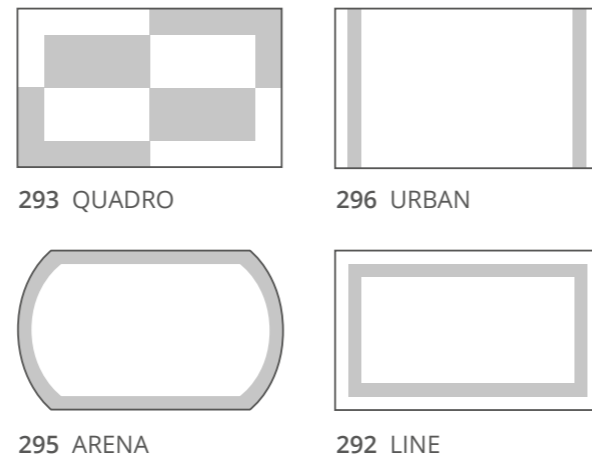

Wunschmaß:

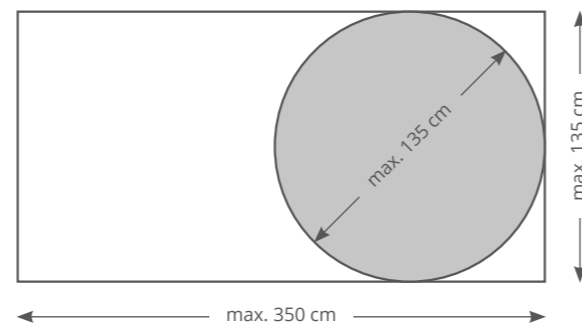

Bitte bestellen Sie wie folgt*:

Art.-Nr.	Form	WuMa	Farbe	Größe
292	12	560	02	75x165
LINE	oval	560	zinn	75x165

*Beispiel

Alle Maße sind Zirka-Maße.
Materialbedingte Maßtoleranzen
(+/-3%) sind möglich.

100% Baumwolle/cotton
Gewicht: ca. 2.250 g/m²
Schlinge/Velours

Keine Rücknahme, kein Umtausch.



DAS BAUMWOLL- WUNSCH-PROGRAMM







829 natur

Mit 15%
Leinen

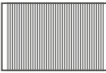

829 natur

02 | LIN

	ca. cm	Art.-Nr.
	50 x 75	02 13 100
	60 x 100	02 13 180
	70 x 130	02 13 230

85% Baumwolle/cotton
15% Leinen/linen
Gewicht ca. 2.250 g/m²
Schlinge/Velours



1462 weiss/natur



829 natur (unbehandelt/nicht gefärbt)



1160 schwarz/natur

DER TAG
BEGINNT
IM BAD.

365 TAGE
IM JAHR.

SAILOR | PEARL | GALA
SEASIDE | PLAIN | COMTESSE | MAURO





1512 navy/natur

56 | SAILOR

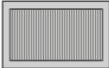
	ca. cm	Art.-Nr.
	50 x 70	56 13 095
	60 x 90	56 13 170
	70 x 120	56 13 220

100% Baumwolle/cotton
Gewicht ca. 1.400 g/m²
gewebt



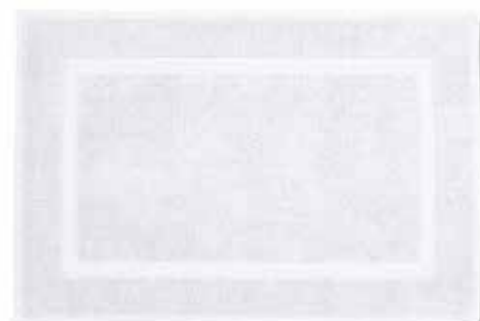

01 weiss



400 aquamarin



20 natur



402 rosenquarz





85 kiesel



90 jade

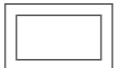

51 | PEARL

	ca. cm	Art.-Nr.
	50 x 70	51 13 095
	60 x 90	51 13 170
	70 x 120	51 13 220

100% Baumwolle/cotton
Gewicht ca. 1.600 g/m²
gewebt



20 natur



390 mais



390 mais



03 | GALA

	ca. cm	Art.-Nr.
	50 x 70	03 13 095
	60 x 90	03 13 170
	70 x 120	03 13 220

100% Baumwolle/cotton
Gewicht ca. 1.800 g/m²
gewebt





90 jade



54 | SEASIDE

	ca. cm	Art.-Nr.
	50 x 70	54 13 095
	60 x 90	54 13 170
	70 x 120	54 13 220

100% Baumwolle/cotton
Gewicht ca. 1.600 g/m²
gewebt



404 olive





20 natur



58 taupe

58 | PLAIN

	ca. cm	Art.-Nr.
	50 x 70	58 13 095
	60 x 90	58 13 170
	70 x 120	58 13 220

100% Baumwolle/cotton
Gewicht ca. 1.800 g/m²
gewebt



21 colours







01 weiss



11 perlgrau

09 | COMTESSE

	ca. cm	Art.-Nr.
	50 x 70	09 13 095
	60 x 100	09 13 180

100% Baumwolle/cotton
Gewicht ca. 1.250 g/m²
Frottiergewebe



20 natur



58 taupe



01 weiss



02 zinn



11 perlgrau



85 kiesel



320 stone



830 natur/weiss

53 | MAURO

	ca. cm	Art.-Nr.
	50 x 70	53 13 095
	60 x 90	53 13 170
	70 x 120	53 13 220

100% Baumwolle/cotton
 Gewicht ca. 1.000 g/m²
 Velours, rutschhemmend



1469 weiss/kiesel



830 natur/weiss

KUSCHELWEICH
WOHLFÜHLEN.



BARONESSE | BARONESSE BADEMANTEL
PRINCESS | SIR & LADY | FACE & BODY
FACE & BODY BADEMANTEL | LOFT | COMTESSE | BEACH





237 berry/405 peach/11 perlgrau

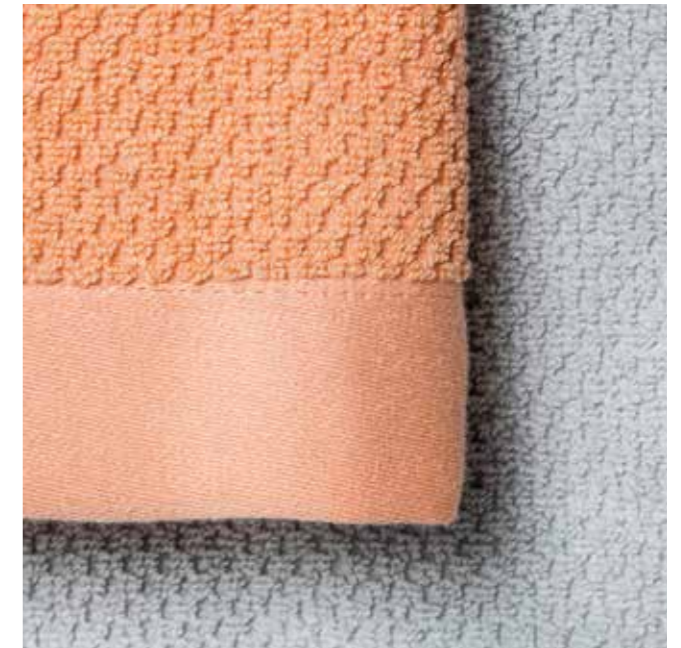

69 | BARONESSE

	ca. cm	Art.-Nr.
	30 x 30	69 82 034
	30 x 50	69 70 036
	50 x 100	69 84 115
	70 x 130	69 75 230
	70 x 190	69 77 246

100% Baumwolle/cotton
Gewicht ca. 500 g/m²





58 taupe/349 cardinal

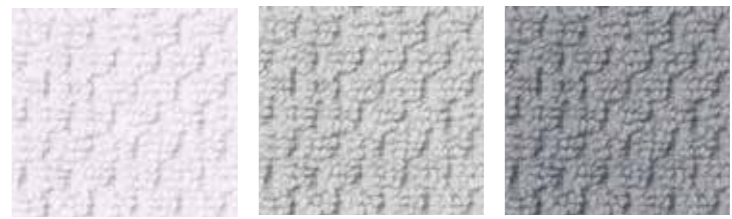

01 weiss 11 perlgrau 85 kiesel

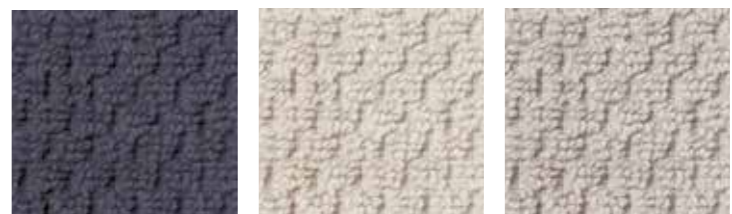

02 zinn 20 natur 320 stone



58 taupe

69 | BARONESSE BADEMANTEL



	Größe	Art.-Nr.
Bademantel unisex	S	69 73 505
	M	69 73 510
	L	69 73 515
	XL	69 73 525

100% Baumwolle/cotton
Gewicht ca. 420 g/m²





66 | PRINCESS

		ca. cm	Art.-Nr.
	ST	30 x 30	66 82 034
	GT	40 x 60	66 70 038
	HT	55 x 100	66 84 150
	DT	70 x 130	66 75 230
	BT	95 x 180	66 77 315
	WH	16 x 22	66 81 030

100% Baumwolle/cotton
Gewicht ca. 650 g/m²





11 kiesel



01 weiss



20 natur



11 perlgrau



85 kiesel



02 zinn



320 stone



58 taupe

250 | SIR & LADY

	Größe	Art.-Nr.
Bademantel unisex	S	250 73 505
	M	250 73 510
	L	250 73 515
	XL	250 73 525

100% Baumwolle/cotton
Gewicht ca. 450 g/m²





68 | FACE & BODY

	ca. cm	Art.-Nr.
	ST 30 x 30	68 82 034
	GT 30 x 50	68 70 036
	HT 50 x 100	68 84 115
	DT 70 x 130	68 75 230
	BT 70 x 190	68 77 246

100% Baumwolle/cotton
Gewicht ca. 440 g/m²



20 natur

85 kiesel

01 weiss

90 jade

402 rosenquarz

400 aquamarin



20 natur



01 weiss

20 natur

85 kiesel

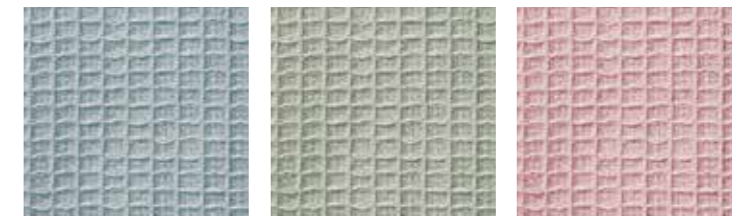

400 aquamarin

90 jade

402 rosenquarz

68 | FACE & BODY BADEMANTEL

	Größe	Art.-Nr.
Bademantel unisex	S	68 73 505
	M	68 73 510
	L	68 73 515
	XL	68 73 525

100% Baumwolle/cotton
Gewicht ca. 420 g/m²

67 | LOFT

	ca. cm	Art.-Nr.
ST	30 x 30	67 82 034
GT	30 x 50	67 70 036
HT	50 x 100	67 84 115
DT	70 x 130	67 75 230
BT	80 x 200	67 77 283

100% Baumwolle/cotton
Gewicht ca. 600 g/m²



85 kiesel



20 natur



11 perlgrau



320 stone



01 weiss



58 taupe



02 zinn



02 zinn/01 weiss/320 stone



09 | COMTESSE

Form	ca. cm	Art.-Nr.
	ST 30 x 50	09 82 034
	GT 30 x 30	09 70 036
	HT 50 x 100	09 84 115
	DT 70 x 130	09 75 230
	BT 80 x 200	09 77 283

100% Baumwolle/cotton
Gewicht ca. 550 g/m²



7 colours



85 kiesel



02 zinn



58 taupe



20 natur



01 weiss



320 stone



11 perlgrau



Nutzen Sie unseren Stick-Service für Frottierprodukte.

Wählen Sie aus verschiedenen Schriften, Motiven und Farben Ihre ganz persönliche Bestickung und veredeln Sie so Ihr Frottier oder Ihren flauschigen Bademantel.

Das ist Ihnen noch nicht individuell genug? Auch Wunschmotive wie beispielsweise Firmenlogos sind kein Problem.

Fragen Sie Ihren Fachhändler, er hilft Ihnen gerne weiter.



Beispiel: C - Lilie

85 kiesel / C80 bordeaux



Q - Ananas
2/3/3/4 Motive*



R - Biene
2/3/3/4 Motive*



S - Engel
1 Motiv



T - Muschel
2/3/3/4 Motive*



U - Lobster
1 Motiv



C - Lilie
3/4/4/5 Motive*



H - Name (Schrift Amazon)
1 Motiv



L - Name (Schrift Book)
1 Motiv



G - Initialen (Schrift Amazon)
1 Motiv

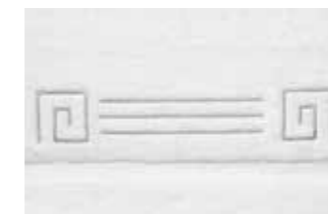

M - Olymp
1 Motiv



E - Mäander
1 Motiv



O - Ihr Firmenlogo
1 Motiv

Lieferbare Stickgarnfarben (Hauptfarbe):

- 01 weiss
- 85 kiesel
- 320 stone
- 400 aquamarin
- 90 jade
- 402 rosenquarz
- 78 aqua
- 239 berry
- 404 olive
- 80 bordeaux
- 73 gold
- 74 silber

*Anzahl der Stickmotive ist von der Frottiertuchgröße abhängig: GT/HT/DT/BT

Wir fertigen auch Ihr Wunsch-Stickmotiv an!



989 grau



43 navy



23 mint

71 | BEACH

Form	ca. cm	Art.-Nr.
	BT 90 x 180	71 77 310

100% Baumwolle/cotton
Gewicht ca. 320 g/m²







(1) Vorleger, **184** thermobuche, (3) Handtuchleiter, **184** thermobuche

Wichtig: Die Holzaccessoires können in einzelnen Fällen auf Naturstein und offenporigen Fliesen, besonders aber auf Marmor abfärben. Daher sind sie nicht auf Natursteinböden zu verwenden!

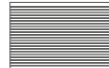

(1) Vorleger, **184** thermobuche

190 | SPA

	ca. cm	Art.-Nr.
	45 x 60 60 x 100	190 13 060 190 13 180
(1) Vorleger		
	20,5 x 85	190 88 033
(2) Wannenbrücke		
	50 x 166	190 89 121
(3) Handtuchleiter		

Material: Thermoholz, 200°C Erhitzung, sehr feuchtigkeitsresistent, formstabil, natürlich dunkle Farbe, umweltfreundlich/keine Chemikalien, geölt.



(2) Wannenbrücke, **184** thermobuche



(1) Wannenbrücke, **185** buche





(1) Wannenbrücke, Silikonringe als Rutschsicherung, **185** buche

(2) Handtuchleiter, **189** thermoesche



186 | ENJOY

	ca. cm	Art.-Nr.
	19 x 84	186 88 033
(1) Wannenbrücke		
	48 x 166	186 89 069
(2) Handtuchleiter		

Ausführung: ovale Stäbe
Material: Holz, Silikonfüße
Lieferbar in Buche und in thermoesche, geölt.
Material: Thermoholz, 200°C Erhitzung, sehr feuchtigkeitsresistent, formstabil, natürlich dunkle Farbe, umweltfreundlich/keine Chemikalien, geölt.





Unsere Badteppiche aus Polyamidgarn sind durch ihre Formstabilität besonders gut geeignet für außergewöhnliche und paßgenaue Ideen unserer Kunden.

Individuelle Badteppiche, angefertigt nach Ihrer eigenen Schablone, machen Ihr Badezimmer zu etwas ganz Besonderem.

Für weitere Informationen wenden Sie sich bitte an Ihren Fachberater.



IHR BADTEPPICH
NACH SCHABLONE.



348 gold

84 kobalt

100% Polyamid/antron
 Gewicht ca. 2.500 g/m²
 Velours flusenfrei
 Rückseite rutschfest latexiert



10 | ASPECT

Form	ca. cm	Art.-Nr.
	50 x 60	10 11 080
	60 x 90	10 11 170
	70 x 120	10 11 220
	80 x 160	10 11 280
	55 x 60	10 51 128
	45 x 50	10 62 050
	max. 180 x 200 Ø 180	10 560

18 | SQUARE

Form	ca. cm	Art.-Nr.
	50 x 60	18 13 080
	60 x 90	18 13 170
	70 x 120	18 13 220
	80 x 160	18 13 280
	55 x 60	18 53 128
	45 x 50	18 62 050
	max. 180 x 200 Ø 180	18 560

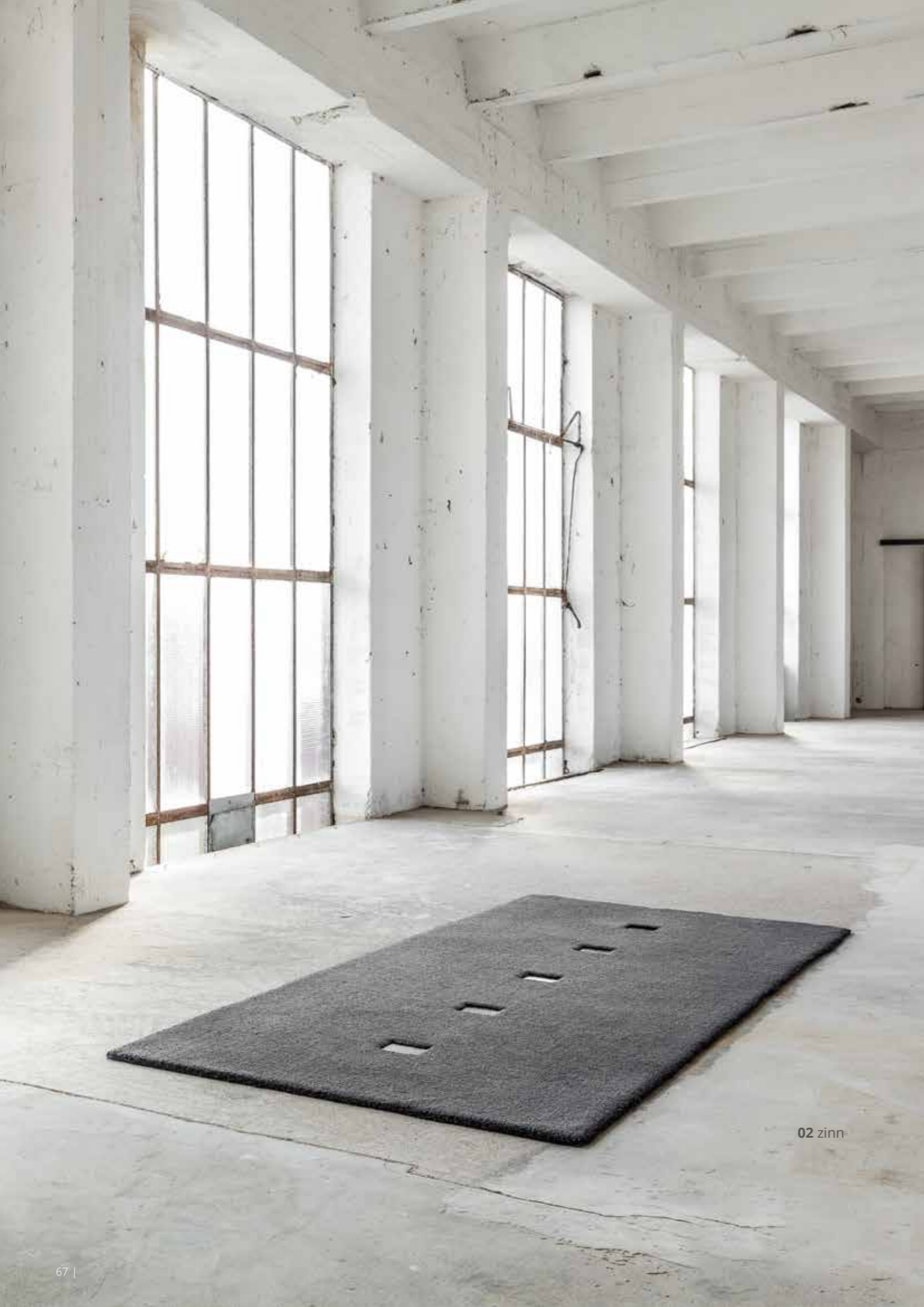

02 zinn

Inlay-Service

Bei den Teppichen der Kollektionen ASPECT und SQUARE haben Sie die Möglichkeit, Edelstahl-Inlays in den Teppich einarbeiten zu lassen.

Sie können dabei aus zwei verschiedenen Inlay-Größen auswählen und die Anordnung und Anzahl selbst bestimmen. Oder entscheiden Sie sich für eine unserer 4 Beispiel-Positionierungen.

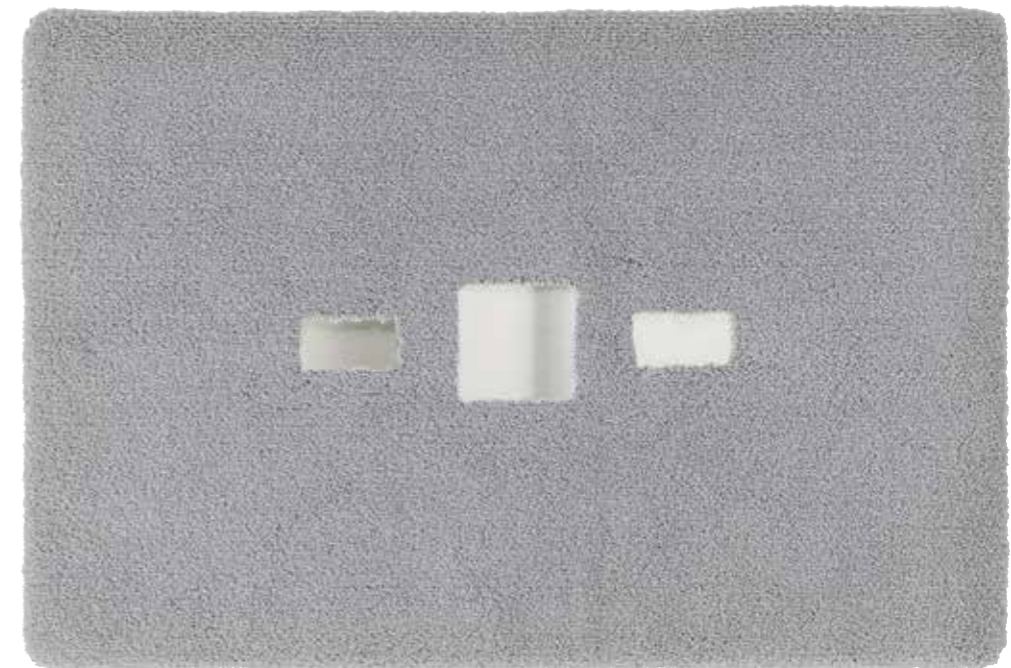

Bitte bestellen Sie wie folgt*:

Art.- Koll.	Form	Größe	Farbe	Inlay	Position
18	13	170	85	i1 i2 i1	(3)
SQUARE	eckig	60x90	kiesel	□□□	(3)

*Beispiel

Edelstahl-Inlays

Inlay 1 (i1) = □ 11,0 x 5,5 cm

Inlay 2 (i2) = □ 11,0 x 11,0 cm

Positionierungs-Beispiele

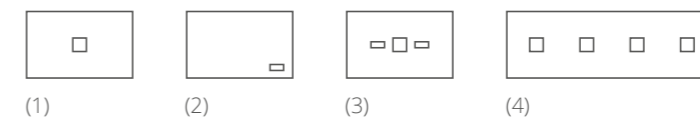

(1)

(2)

(3)

(4)

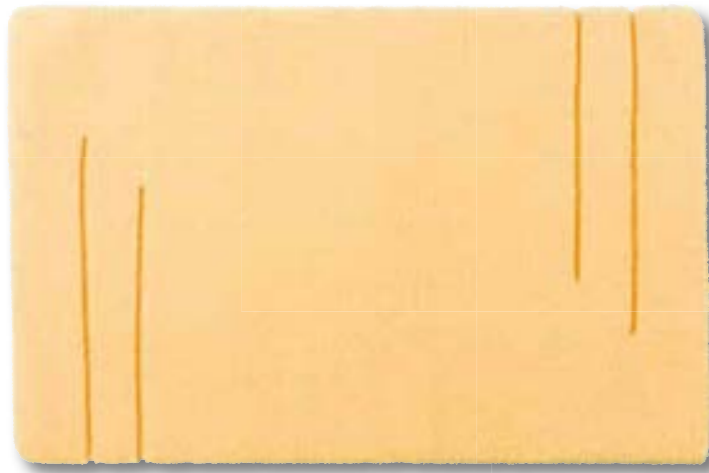

390 mais



360 | EFFECT

	ca. cm	Art.-Nr.
	50 x 60	360 13 080
	60 x 90	360 13 170
	70 x 120	360 13 220
	80 x 160	360 13 280
	55 x 60	360 53 128
	45 x 50	360 62 050
	max. 180 x 200 Ø 180	360 560

Effektiv
geschorene
Badteppiche



320 stone



361 | RAUTE

	ca. cm	Art.-Nr.
	50 x 60	361 11 080
	60 x 90	361 11 170
	70 x 120	361 11 220
	80 x 160	361 11 280
	55 x 60	361 51 128
	45 x 50	361 62 050
	max. 180 x 200 Ø 180	361 560



400 aquamarin



362 | BAHAMA

	ca. cm	Art.-Nr.
	50 x 60	362 11 080
	60 x 90	362 11 170
	70 x 120	362 11 220
	80 x 160	362 11 280
	55 x 60	362 51 128
	45 x 50	362 62 050
	max. 180 x 200 Ø 180	362 560

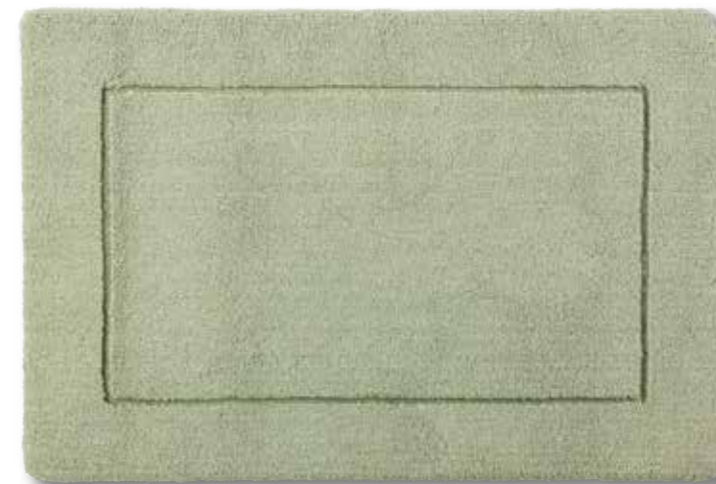

90 jade



363 | BOLERO

	ca. cm	Art.-Nr.
	50 x 60	363 13 080
	60 x 90	363 13 170
	70 x 120	363 13 220
	80 x 160	363 13 280
	55 x 60	363 53 128
	45 x 50	363 62 050
	max. 180 x 200 Ø 180	363 560

ANTRON WUNSCH- PROGRAMM.

Wählen Sie Ihren Favoriten zum Wunschmaß-Preis

Wählen Sie aus den nebenstehenden Wunschformen Ihren Lieblings-Badteppich. Oder schicken Sie uns Ihre ganz persönliche Schablone. 21 moderne Farben und Größen von 50 x 50 bis max. 180 x 200 cm lassen keine Wünsche offen.

Wunschformen:

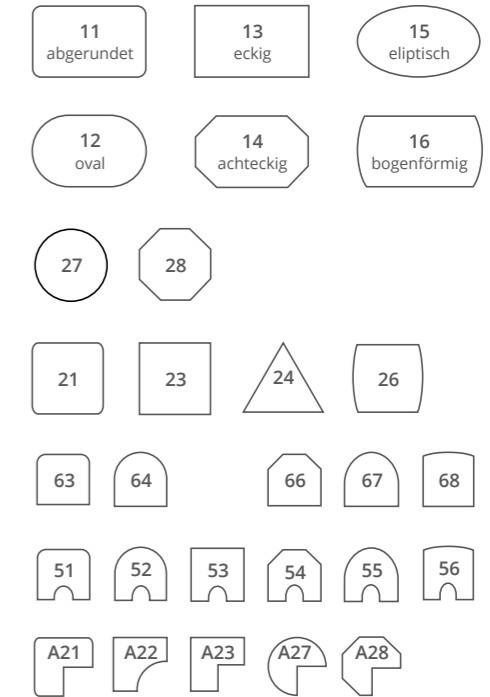

Wunschmaß:

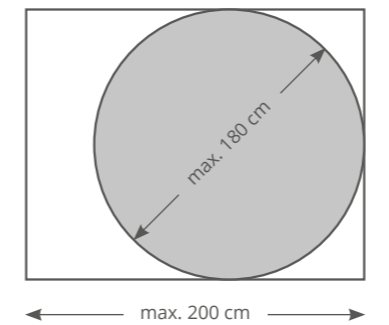

Bitte bestellen Sie wie folgt*:

Art.-Koll.	Form	WuMa	Farbe	Größe
10	12	560	02	75x165
ASPECT	oval	560	zinn	75x165

*Beispiel

Höhe 20 mm



Rückseite latexiert, absolut rutschfest

Alle Maße sind Zirka-Maße. Materialbedingte Maßtoleranzen (+/-3%) sind möglich.

100% Polyamid/antron
Gewicht: ca. 2.500 g/m²
Velours, Rückseite latexiert





Gestalten Sie Ihren persönlichen Badteppich. Dank unseres Tuft-Roboters sind wir in der Lage mit unseren Acrylgarnen individuelle Muster und Formen zu tuften bis zu einer maximalen Größe von 290 x 390 cm. So ist es z.B. kein Problem, das Dekor einer Fliese umzusetzen. So geben Sie Ihrem Bad eine ganz persönliche Note.

Sprechen Sie Ihren Fachberater doch einfach darauf an.

WÜNSCH DIR WAS...

INDIVIDUELL, MEHRFARBIG, DESSINIERT.

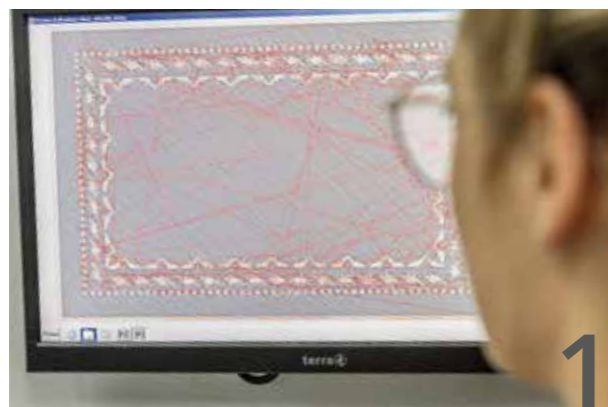









1305 ecru/beige/walnuss



1304 malve/hibiscus/magnolia

24 | AMBIENTE

	ca. cm	Art.-Nr.
	60 x 90 70 x 120 70 x 150 80 x 160	24 12 170 24 12 220 24 12 235 24 12 280
	Ø 80 Ø 100 Ø 120	24 27 435 24 27 445 24 27 450
	50 x 65	24 41 090
	60 x 60	24 12 160
	60 x 60	24 52 160
	45 x 50	24 62 050
	max. 160 x 350 Ø 160	24 560

Wunschfarbe
ohne Aufpreis

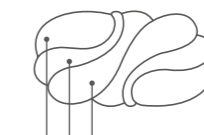

a b c (dreifarbig)

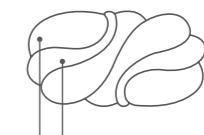

a b (zweifarbzig)

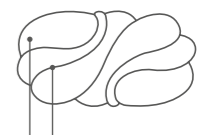

a b (ohne Kurzflorstreifen)

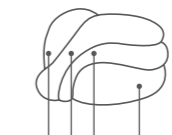

a b c a

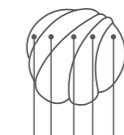

c b a b c



c b a



100% Polyacryl/acrylic
Gewicht ca. 2.200 g/m²
Velours, Rückseite
rutschhemmend



260 ecru, 1-farbig



1473 curry/neptun, 2-farbig,
ohne Kurzflorstreifen



1310 polarblau/ultramarin/royal, 3-farbig



1321 weiss/weiss-goldlurex



1322 weiss/weiss-silberlurex

36 | MÄANDER

Form	ca. cm	Art.-Nr.
	50 x 65	36 13 090
	60 x 90	36 13 170
	70 x 120	36 13 220
	70 x 150	36 13 235
	80 x 160	36 13 280
	60 x 60	36 43 160
	60 x 60	36 53 160
	Ø 80	36 27 435
	Ø 100	36 27 445
	Ø 120	36 27 450
	45 x 50	36 62 050
	auf Anfrage max. 160 x 350 Ø 160	36 560

100% Polyacryl/acylic
Gewicht ca. 2.200 g/m²
Velours, Rückseite
rutschhemmend

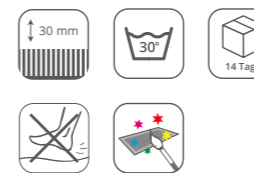

Wunschfarbe
99 Farben ohne Aufpreis

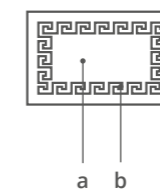

0981 weiss/goldlurex



936 natur/goldlurex



1474 weiss/kiesel



1475 schwarz/kastanie



1479 bordeaux/malve/schwarz

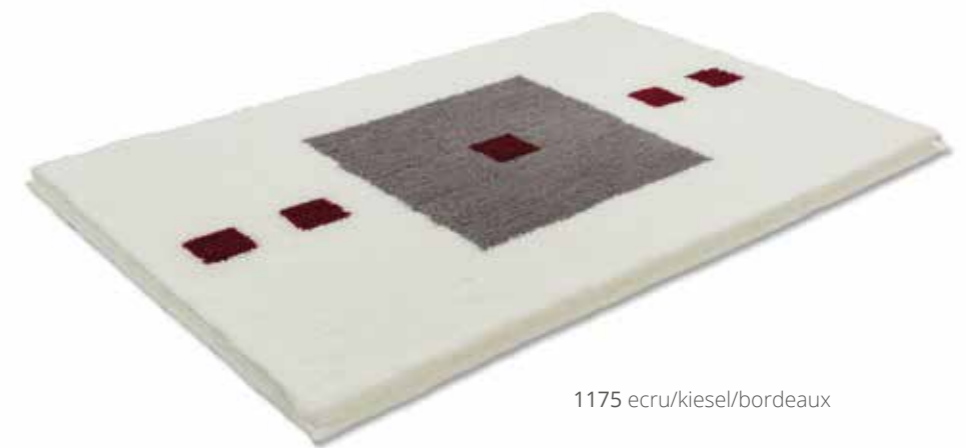

1175 ecru/kiesel/bordeaux

31 | CUBUS

	*	ca. cm	Art.-Nr.
	5	60 x 90	31 13 170
	9	70 x 120	31 13 220
	11	70 x 150	31 13 235
	11	80 x 160	31 13 280
	5	Ø 90	31 27 440
	5	90 x 90	31 13 289
	3	50 x 65	31 43 090
	3	60 x 60	31 13 160
	2	60 x 60	31 53 160
		45 x 50	31 62 050
		max. 160 x 350 Ø 160	31 560

*Anzahl der Quadrate ändert sich mit der Größe des Badteppichs!

Diese Außenformen sind **ohne Aufpreis** lieferbar.

- 11 abgerundet
- 12 oval
- 13 eckig
- 14 achteckig
- 15 elliptisch
- 16 bogenförmig

Wunschfarbe
99 Farben ohne Aufpreis

100% Polyacryl/acrylic
Gewicht ca. 2.200 g/m²
Velours, Rückseite rutschhemmend

1381 malachit/mint/weiss

1478 royal/aqua/silbergrau



1476 natur/marone

87 | RHOM

	ca. cm	Art.-Nr.
	50 x 65	87 13 090
	60 x 60	87 13 160
	60 x 90	87 13 170
	70 x 120	87 13 220
	70 x 150	87 13 235
	80 x 160	87 13 280
	60 x 60	87 53 160
	45 x 50	87 62 050
	max. 160 x 350 Ø 160	87 560

100% Polyacryl/acrylic
Gewicht ca. 2.200 g/m²
Velours, Rückseite
rutschhemmend

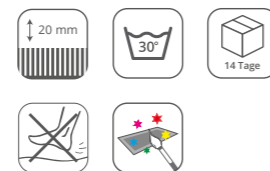

Wunschfarbe
99 Farben ohne Aufpreis

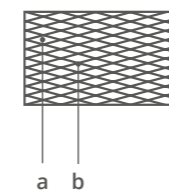

1377 sonne/banane



1480 natur/zink



1481 erdbeer/crevette



87 | RHOM



1476 natur/marone



1482 stone/weiss/gold-lurex



1482 stone/weiss/goldlurex

300 | CABLE

	ca. cm	Art.-Nr.
	50 x 65	300 13 090
	60 x 60	300 13 160
	60 x 90	300 13 170
	70 x 120	300 13 220
	70 x 150	300 13 235
	80 x 160	300 13 280
	60 x 60	300 53 160
	45 x 50	300 62 050
	max. 160 x 350 Ø 160	300 560

100% Polyacryl/acylic
 Gewicht ca. 2.200 g/m²
 Velours/Schlinge,
 Rückseite rutsch-
 hemmend



Wunschfarbe
 99 Farben ohne Aufpreis

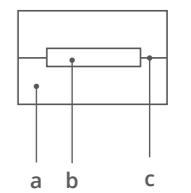

c = Schlinge

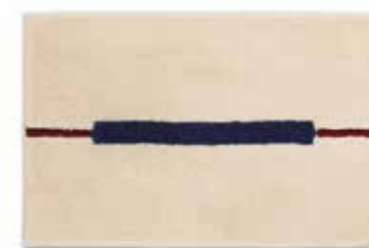

1483 beige/kobalt/cardinal



1484 lind/moos/bordeaux



1482 stone/weiss/goldlurex







1015 zink/weiss



1015 zink/weiss

301 | FRAME

	ca. cm	Art.-Nr.
	50 x 65	301 13 090
	60 x 60	301 13 160
	60 x 90	301 13 170
	70 x 120	301 13 220
	70 x 150	301 13 235
	80 x 160	301 13 280
	60 x 60	301 53 160
	45 x 50	301 62 050
	max. 160 x 350 Ø 160	301 560

Wunschfarbe
99 Farben ohne Aufpreis

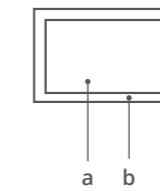

b = Schlinge



100% Polyacryl/acylic
Gewicht ca. 2.200 g/m²
Velours/Schlinge,
Rückseite rutsch-
hemmend

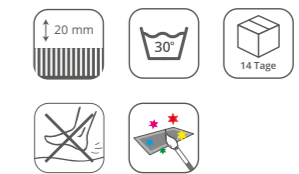

1374 ecru/creme



1314 moor/stone



632 weiss/carmin



1474 weiss/kiesel

302 | PUZZLE

	ca. cm	Art.-Nr.
	60 x 80	302 14 165
	65 x 95	302 14 214

Kein Wunschmaß möglich.



1474 weiss/kiesel

100% Polyacryl/acylic
Gewicht ca. 2.200 g/m²
Velours, Rückseite
rutschhemmend



Wunschfarbe
99 Farben ohne Aufpreis

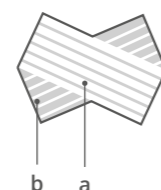







1215 edelstahl/weiss



1215 edelstahl/weiss

216 | STAR

	ca. cm	Art.-Nr.
	50 x 65 60 x 60 60 x 90 70 x 120 70 x 150 80 x 160	216 13 090 216 13 160 216 13 170 216 13 220 216 13 235 216 13 280
	60 x 60	216 53 160
	45 x 50	216 62 050
	max. 290 x 390 Ø 290	216 560

Wunschfarbe
99 Farben ohne Aufpreis

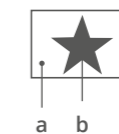

a b

100% Polyacryl/acylic
Gewicht ca. 2.800 g/m²
Velours, Rückseite
rutschhemmend



1341 weiss/edelstahl



1335 stone/weiss



1464 schwarz/graphit



1396 weiss/schwarz/blei

243 | STEP

	*	ca. cm	Art.-Nr.
	3	60 x 90	243 13 170
	3	70 x 120	243 13 220
	3	70 x 150	243 13 235
	4	80 x 160	243 13 280
	2	50 x 65	243 13 090
	2	60 x 60	243 13 160
	2	60 x 60	243 53 160
		45 x 50	243 62 050
		max. 160 x 350 Ø 160	243 560

Wunschfarbe
99 Farben ohne Aufpreis

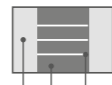

a b c
c = Schlinge



*Anzahl der Streifen ändert sich mit der Größe des Badteppichs!

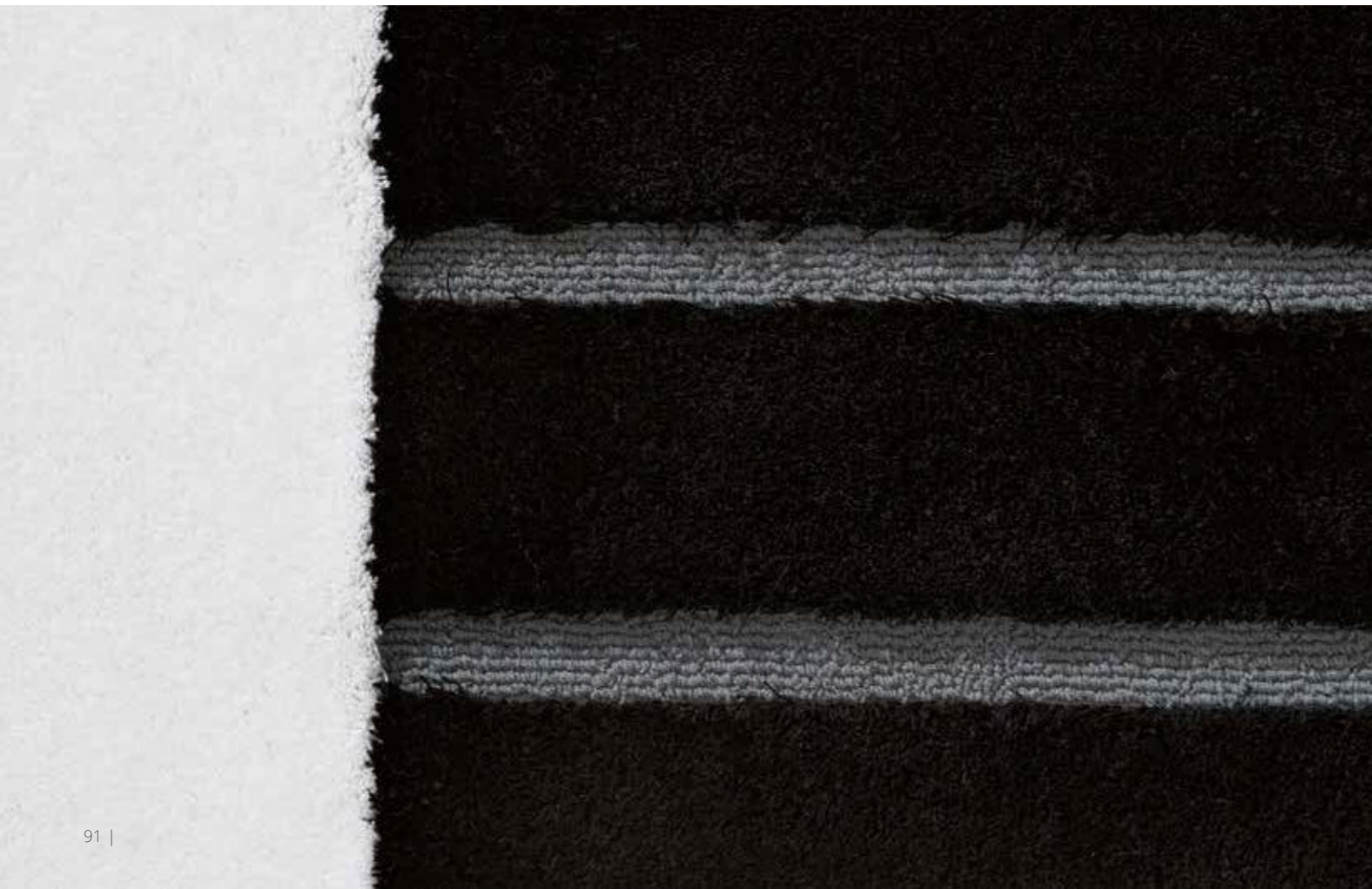
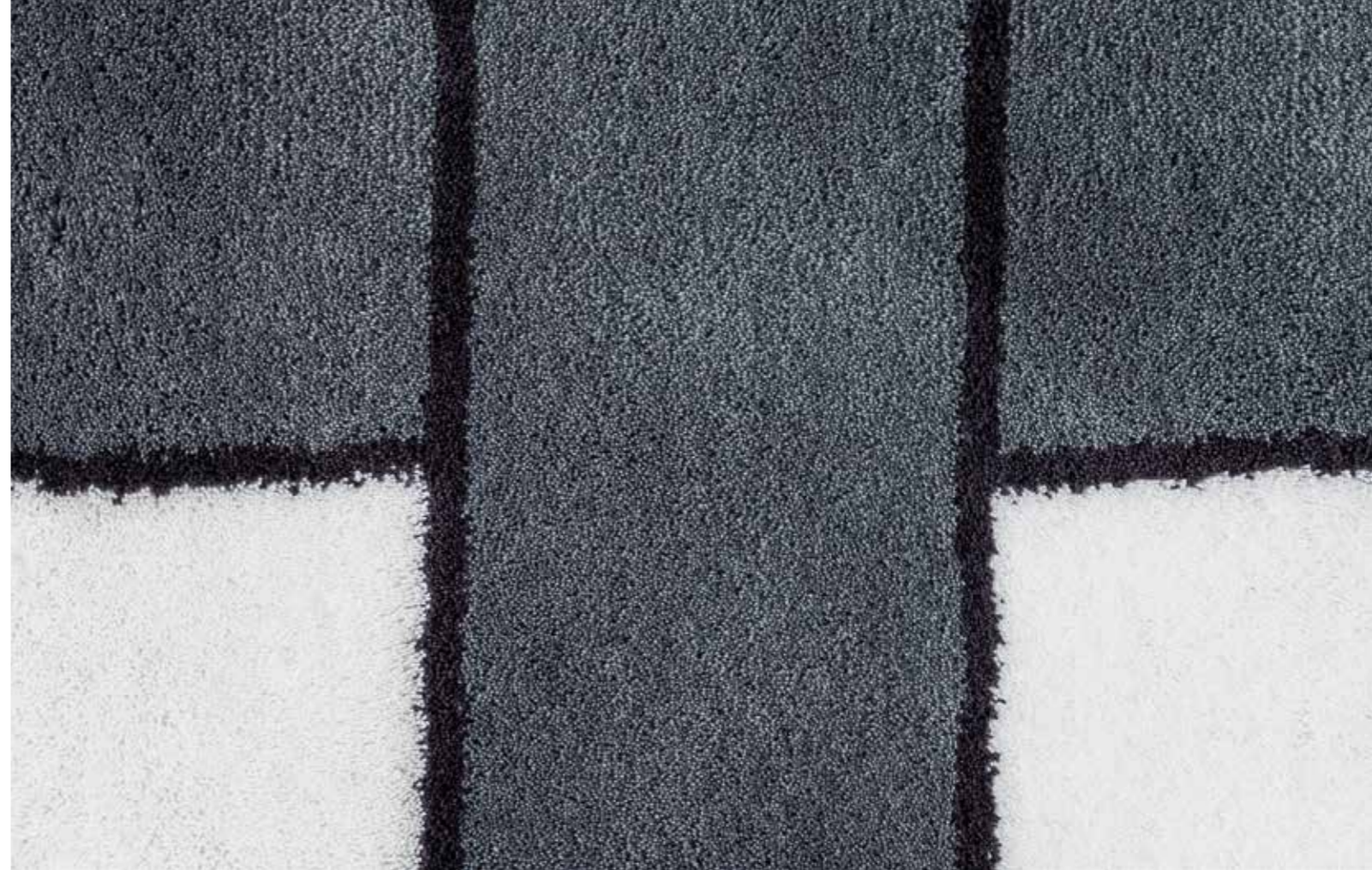

1510 zink/weiss/schwarz

308 | STONE

	ca. cm	Art.-Nr.
	50 x 65	308 13 090
	60 x 60	308 13 160
	60 x 90	308 13 170
	70 x 120	308 13 220
	70 x 150	308 13 235
	80 x 160	308 13 280
	60 x 60	308 53 160

Wunschfarbe
99 Farben ohne Aufpreis

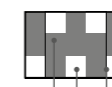

a b c







	45 x 50	308 62 050
	max. 160 x 350 Ø 160	308 560



1509 weiss/curry-goldlurex

306 | ANANAS

	ca. cm	Art.-Nr.
	50 x 65	306 13 090
	60 x 60	306 13 160
	60 x 90	306 13 170
	70 x 120	306 13 220
	70 x 150	306 13 235
	80 x 160	306 13 280
	60 x 60	306 53 160
	45 x 50	306 62 050
	max. 290 x 390 Ø 290	306 560

Wunschfarbe
99 Farben ohne Aufpreis

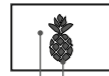





a b
b = Schlinge



1368 royal/weiss/weiss-goldlurex

223 | ANKER

	ca. cm	Art.-Nr.
	50 x 65	223 13 090
	60 x 60	223 13 160
	60 x 90	223 13 170
	70 x 120	223 13 220
	70 x 150	223 13 235
	80 x 160	223 13 280
	60 x 60	223 53 160
	45 x 50	223 62 050
	max. 290 x 390 Ø 290	223 560

Wunschfarbe
99 Farben ohne Aufpreis







a c b
c = Schlinge



1491air/weiss

135 | LINEA

	ca. cm	Art.-Nr.
	50 x 65	135 13 090
	60 x 60	135 13 160
	60 x 90	135 13 170
	70 x 120	135 13 220
	70 x 150	135 13 235
	80 x 160	135 13 280
	60 x 60	135 53 160
	45 x 50	135 62 050
	max. 160 x 350 Ø 160	135 560

Wunschfarbe
99 Farben ohne Aufpreis



b a





1321 weiss/weiss-goldlurex

303 | MÄANDER MONO

	ca. cm	Art.-Nr.
	50 x 65	303 13 090
	60 x 60	303 13 160
	60 x 90	303 13 170
	70 x 120	303 13 220
	70 x 150	303 13 235
	80 x 160	303 13 280

Wunschfarbe
99 Farben ohne Aufpreis

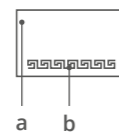

	60 x 60	303 53 160
	45 x 50	303 62 050
	max. 160 x 350 Ø 160	303 560



1511 natur/opal/calypso

233 | STARFISH

	ca. cm	Art.-Nr.
	50 x 65	233 13 090
	60 x 60	233 13 160
	60 x 90	233 13 170
	70 x 120	233 13 220
	70 x 150	233 13 235
	80 x 160	233 13 280

Wunschfarbe
99 Farben ohne Aufpreis



	60 x 60	233 53 160
	45 x 50	233 62 050
	max. 160 x 350 Ø 160	233 560



1471 bordeaux/goldlurex

37 | OLYMP

	ca. cm	Art.-Nr.
	50 x 65	37 13 090
	60 x 60	37 13 160
	60 x 90	37 13 170
	70 x 120	37 13 220
	70 x 150	37 13 235
	80 x 160	37 13 280

Wunschfarbe
99 Farben ohne Aufpreis

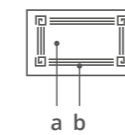

	60 x 60	37 53 160
	45 x 50	37 62 050
	max. 160 x 350 Ø 160	37 560



1485 aqua/air/kobalt

122 | SWOOP

	ca. cm	Art.-Nr.
	50 x 65	122 13 090
	60 x 90	122 13 170
	70 x 120	122 13 220
	70 x 150	122 13 235
	80 x 160	122 13 280

Wunschfarbe
99 Farben ohne Aufpreis

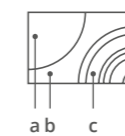

	60 x 60	122 53 160
	45 x 50	122 62 050
	max. 160 x 350 Ø 160	122 560



1486 lind/moos

244 | VIVO

	ca. cm	Art.-Nr.
	60 x 90	244 15 170
	70 x 120	244 15 220
	70 x 150	244 15 235
	80 x 160	244 15 280
	50 x 65	244 15 090
	60 x 60	244 15 160
	60 x 60	244 55 160
	45 x 50	244 62 050
	max. 160 x 350 Ø 160	244 560

Wunschfarbe
99 Farben ohne Aufpreis

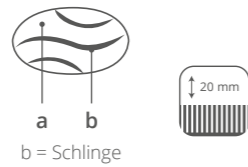

b = Schlinge



1488 schwarz/beige/weiss

327 | LUNA

	ca. cm	Art.-Nr.
	50 x 65	327 13 090
	60 x 90	327 13 170
	70 x 120	327 13 220
	70 x 150	327 13 235
	80 x 160	327 13 280
	60 x 60	327 13 160
	60 x 60	327 53 160
	45 x 50	327 62 050
	max. 290 x 390 Ø 290	327 560

Wunschfarbe
99 Farben ohne Aufpreis



1489 crevette/sumatra

304 | MONSTERA

	ca. cm	Art.-Nr.
	50 x 65	304 13 090
	60 x 90	304 13 170
	70 x 120	304 13 220
	70 x 150	304 13 235
	80 x 160	304 13 280
	60 x 60	304 13 160
	60 x 60	304 53 160
	45 x 50	304 62 050
	max. 290 x 390 Ø 290	304 560

Wunschfarbe
99 Farben ohne Aufpreis



a b



1483 beige/kobalt/cardinal

237 | MARITIM

	ca. cm	Art.-Nr.
	50 x 65	237 13 090
	60 x 60	237 13 160
	60 x 90	237 13 170
	70 x 120	237 13 220
	70 x 150	237 13 235
	80 x 160	237 13 280
	60 x 60	237 53 160
	45 x 50	237 62 050
	max. 160 x 350 Ø 160	237 560

Wunschfarbe
99 Farben ohne Aufpreis

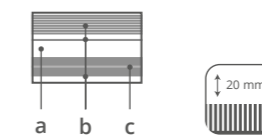

a b c



219 | ELK

1404 kiesel/carmin



221 | ZEBRA

904 schwarz/weiss

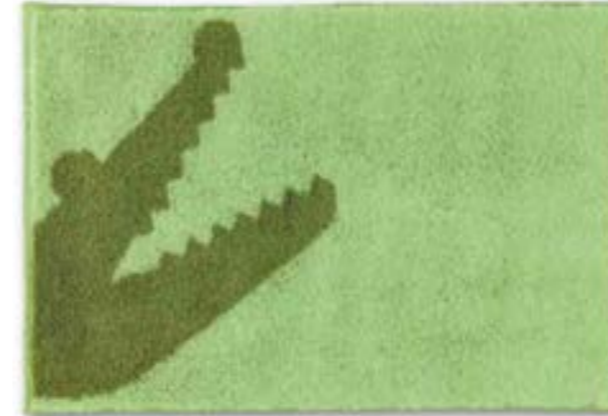

203 | CROC

1207 apfel/lind



309 | WINDROSE

858 silbergrau/
schwarz/perlgrau

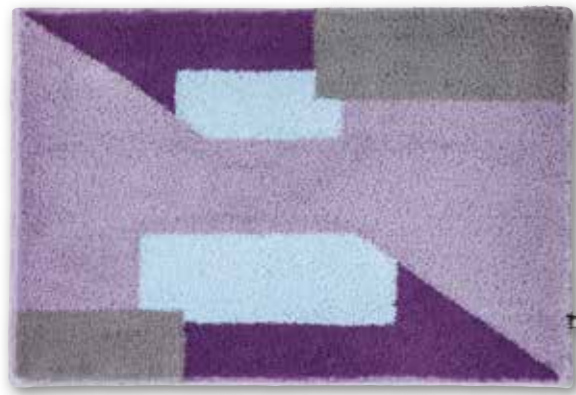

305 | GEOMETRIC

1490 amethyst/
perlgrau/dahlie/air



224 | LILIE

1372 bordeaux/ecru



313 | CROWN

1495 kobalt/weiss-goldlurex



314 | ENGEL

1496 schwarz/caramel



310 | FLAMINGO

1492 kiesel/
weiss/hummer/
rotorange



311 | NEW LORD

1493 sumatra/
edelweiss



312 | LOBSTER

1494 ecru/carmin



315 | PUMP

1497 edelweiss/
erdbeer/bordeaux/moor

	ca. cm	Art.-Nr.
	50 x 65 13 090
	60 x 60 13 160
	60 x 90 13 170
	70 x 120 13 220
	70 x 150 13 235
	80 x 160 13 280
	60 x 60 53 160
	45 x 50 62 050
	max. 560
	290 x 390 Ø 290	

Größen bzw. Anzahl der Motive auf einem Badteppich können produktionsbedingt variieren.

Wunschfarbe: 99 Farben ohne Aufpreis

100% Polyacryl/acylic
Gewicht ca. 2.800 g/m²
Velours, Rückseite
rutschhemmend





316 | BIRDS 1498 zinn/schwarz



317 | NEW ZEBRA 1499 neptun/banane



318 | SEGELBOOT 1500 air/kastanie/weiss



319 | TANNENBAUM 1501 edelweiss/moos/
bordeaux/goldlurex



320 | KING 1502 air/amethyst



321 | QUEEN 1503 amethyst/air



322 | SCHNEEFLOCKE 1504 air/weiss-silberlurex



323 | MUSCHEL 1505 edelweiss/
goldlurex/creme



325 | YACHT 1507 himmel/weiss/
edelstahl/schwarz



326 | KLEX 1508 edelweiss/cardinal

	ca. cm	Art.-Nr.
	50 x 65 13 090
	60 x 60 13 160
	60 x 90 13 170
	70 x 120 13 220
	70 x 150 13 235
	80 x 160 13 280
	60 x 60 53 160
	45 x 50 62 050
	max. 560
	290 x 390 Ø 290	

Größen bzw. Anzahl der Motive auf einem Badteppich können produktionsbedingt variieren.

Wunschfarbe: 99 Farben ohne Aufpreis

100% Polyacryl/acylic
Gewicht ca. 2.800 g/m²
Velours, Rückseite
rutschhemmend

Wünsch Dir was!

Konfigurieren Sie Ihren ganz persönlichen unifarbenen Polyacryl-Badteppich aus den nebenstehenden 28 Formen, 99 Farben und 2 Florhöhen – auch in Wunschmaß/-form bis max.160 x 350 cm.



Form 14



Form 11



Form 12



Form 13



Form 16



Form 15

28 Formen, 99 Farben, 2 Florhöhen – unendliche Möglichkeiten.

			ca. cm	20 COMPACT	22 COMFORT
11 abgerundet	13 eckig	15 elliptisch	50 x 65 60 x 90 70 x 120 70 x 150 80 x 160	20 .. 090 20 .. 170 20 .. 220 20 .. 235 20 .. 280	22 .. 090 22 .. 170 22 .. 220 22 .. 235 22 .. 280
12 oval	14 achteckig	16 bogenförmig			
27	28		Ø 80 Ø 100 Ø 120	20 .. 435 20 .. 445 20 .. 450	22 .. 435 22 .. 445 22 .. 450
21	23	24	80 x 80 100 x 100 120 x 120	20 .. 250 20 .. 320 20 .. 340	22 .. 250 22 .. 320 22 .. 340
63	64	66	60 x 60	20 .. 160	22 .. 160
51	52	53	60 x 60	20 .. 160	22 .. 160
54	55	56			
			45 x 50	20 62 050	22 62 050
A21	A22	A23	max. 160 x 350 Ø 160	20 .. 560	22 .. 560
			max. 160 x 350 Ø 160	20 .. 560	22 .. 560

Wunschmaß:

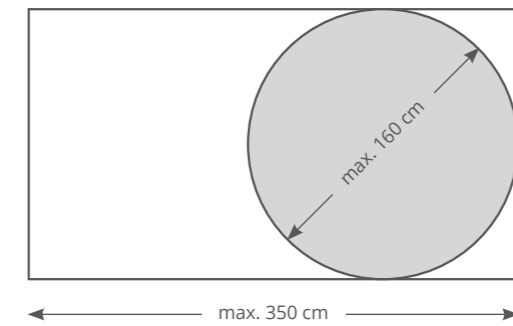

Die folgenden Außenformen fertigen wir in Standardgrößen ohne Aufpreis:

- 11 = abgerundet
- 12 = oval
- 13 = eckig
- 14 = achteckig
- 15 = elliptisch
- 16 = bogenförmig

Wunschformen nach Schablone/Skizze möglich.

99 Farben und weitere Informationen entnehmen Sie bitte den hinteren Umschlagseiten und den Seiten 103-104.



Darstellung der Florhöhen in Originalgröße.



WASCH- UND PFLEGETIPPS

Beachten Sie bitte vor dem Waschen und Reinigen der RHOMTUFT-Artikel die Pflegekennzeichen und die Waschsymbole, die Sie auf den Etiketten und Anhängern an der Ware finden.

In der RHOMTUFT Manufaktur setzen wir hochwertige Garne und Materialien ein, mit denen wir exzellente Gebrauchseigenschaften erzielen. Unsere hochwertige Stück- und Garn-Färbung ist überdurchschnittlich farbecht und farbkonstant. Damit die Farben nicht verblassen bitte Feinwaschmittel ohne optische Aufheller verwenden.

...für Badteppiche

Unsere getufteten Badteppiche aus Baumwolle sind bis 95° waschbar, alle 21 Farben! Gewebte Badteppiche aus Baumwolle bis 60°; Badteppiche aus Polyamid- und Acrylgarn bis 30° C.

Der Flor der Badteppiche geht bauschig auf, wenn im letzten Spülgang ein Weichspüler verwendet wird. Waschen Sie bitte gleichfarbige Garnituren zusammen. Nach der Wäsche die Badteppiche im Wäschetrockner bei reduzierter Temperatur oder im Freien trocknen. Bitte nicht auf eine Heizung legen oder direkter Sonnenstrahlung aussetzen.

ACHTUNG:

Vor und nach den ersten Waschvorgängen anfallende Flusen bitte aus dem Waschmaschinen- und Trocknersieb entfernen. Ein anfänglich leichtes Flusen ist materialbedingt und reduziert sich nach einigen Wäschen auf ein Minimum. Gelegentliches Aufschütteln der Teppiche nach der Wäsche und im Gebrauch gibt dem Flor sein ursprüngliches Volumen zurück; besonders bei getufteten Badteppichen aus Baumwolle.

...für Frottier

Unser schweres und flauschiges Frottier ist bis 60° waschbar. Verwenden Sie bitte Feinwaschmittel ohne optische Aufheller, welches sich auch besonders für farbiges Frottier eignet. Kein Waschmittel einsetzen, welches ein Ausbleichen der Farben zur Folge haben kann.

Ihre Waschmaschine sollte immer gut gefüllt sein. Eine unzureichend gefüllte oder überfüllte Waschtrommel strapaziert die Wäsche zu sehr. Trennen Sie vorher helle und dunkle Farben.

Dosieren Sie Ihr Waschmittel richtig; zu viel Waschmittel kann die Fasern absetzen und verhärten; Farben verlieren ihre Leuchtkraft. Weichmacher begünstigen die Flusenbildung.

Nach der Wäsche das Frottier im Wäschetrockner bei reduzierter Temperatur oder im Freien trocknen. So kann auf Weichspüler verzichtet werden. Bitte das Frottier nicht auf eine Heizung legen oder direkter Sonnenstrahlung aussetzen.

Fäden stehen ab – keine Sorge! Frottier ist ein Schlingengewebe, daher können Sie gezogene Fäden einfach mit einer Schere kurz abschneiden. Bitte nicht Fäden ziehen.

...für Holz-Accessoires

RHOMTUFT Holz-Accessoires können problemlos im Feucht- und Badbereich verwendet werden, sollten aber nicht dauerhaft auf feuchtem Untergrund liegen.

Je nach Verschmutzung bitte die Holzaccessoires mit einem feuchten Tuch mit Wasser reinigen. Keine Chemikalien oder andere Reiniger verwenden!

Um Aussehen und Langlebigkeit zu gewährleisten, können Sie unsere Holzartikel von Zeit zu Zeit mit einem handelsüblichen Öl (Lein-, Teak oder Möbel-Öl) einreiben. Bitte anschließend ausreichend lange einziehen lassen, überschüssiges Öl abreiben.

Achtung:

Holzvorleger/Accessoires können auf offenporigen Fliesen und Fußböden abfärben! Daher sind sie nicht auf Natursteinböden wie Marmor zu verwenden.

Bitte beachten Sie unsere Wasch- und Pflegetipps, damit Sie an unseren hochwertigen Produkten viele Jahre Ihre Freude haben. Bei unsachgemäßer Behandlung müssen wir jede Haftung ablehnen.

3 JAHRE GEWÄHRLEISTUNG

Wir geben auf die Haltbarkeit des Flors und der Rückenbeschichtung unserer Badteppiche eine dreijährige Gewährleistung. Sollte trotz sachgemäßer Behandlung und Pflege und bei normaler Beanspruchung ein Schaden auftreten, so wird der schadhafte Badteppich von uns bei Vorlage des Kaufbelegs gegen einen Ersatz-Badteppich der gleichen Preisklasse umgetauscht. Bitte wenden Sie sich an Ihren Fachhändler, bei dem Sie unseren Badteppich gekauft haben.

Weitere Pflegehinweise finden

Sie unter www.rhomtuf.de

Technische Änderungen vorbehalten.

Care instructions www.rhomtuf.de

Technical changes reserved.

BADTEPPICHE AUS POLYACRYLGARN

Standardgrößen, Wunschfarben, Wunschmaßanfertigungen, Wunschformen, Schablone/Skizze.

Auftragsbezogene Fertigung (Einzelfertigung), kein Rücktritt vom Auftrag möglich, keine Rücknahme, kein Umtausch.

Maßtoleranzen (+/-3%) sind möglich.

Lieferzeit: ca. 14 Tage!



99 FARBEN / POLYACRYLFARBSTREIFEN / COLORBOX

für Badteppiche aus Polyacrylgarn



Farbabweichungen zu den Mustern des Farbstreifens und von Färbepartie zu Färbepartie sind herstellungsbedingt nicht auszuschließen.

Drucktechnisch bedingt können Farben vom Original abweichen.

Colors can deviate from the original.

Verwendung von Lurex-Garnen: Für das Befuhen von großen Flächen (z.B. Motiv / Artikel Lilie) mit Gold- und Silberlurex, erheben wir einen Aufpreis!



RHOMTUFT®

RHOMTUFT GmbH | Langes Feld 10 | 31860 Emmerthal | Deutschland
Fon +49 (0) 5155/620-23 | Fax +49 (0) 5155/620-90

E-Mail verkauf@rhomtuf.de | export@rhomtuf.de

www.rhomtuf.de